

Standard Development Timeline

This section is maintained by the drafting team during the development of the standard and will be removed when the standard becomes effective.

Development Steps Completed

1. The Standards Committee accepted the Standard Authorization Request (SAR) submitted by the Geomagnetic Disturbance Task Force (GMD TF) and approved Project 2013-03 (Geomagnetic Disturbance Mitigation) on June 5, 2013.
2. The SAR was posted for informal comment from June 26, 2013 through August 12, 2013.

Description of Current Draft

This ~~draft~~ is the first ~~posting~~draft of the proposed ~~standard~~Reliability Standard. It is posted for a ~~30~~45-day ~~informal~~-comment and initial ballot.

Anticipated Actions	Anticipated Date
45-day Formal Comment Period with Initial Ballot	June 2014
45-day Formal Comment Period with Additional Ballot	August 2014
Final ballot	October 2014
BOT adoption	November 2014

Effective Dates

The definition shall become effective on the first day of the first calendar quarter after the date that this standard is approved by an applicable governmental authority or as otherwise provided for in a jurisdiction where approval by an applicable governmental authority is required for a standard to go into effect. Where approval by an applicable governmental authority is not required, the definition shall become effective on the first day of the first calendar quarter after the date this standard is adopted by the NERC Board of Trustees or as otherwise provided for in that jurisdiction.

The Requirements shall become effective as described in the Implementation Plan beginning on the first day of the first calendar quarter that is 12 months after the date that this standard is approved by an applicable governmental authority or as otherwise provided for in a jurisdiction where approval by an applicable governmental authority is required for a standard to go into effect. Where approval by an applicable governmental authority is not required, the Requirements shall become effective as described in the Implementation Plan beginning on the first day of the first calendar quarter that is 12 months after the date this standard is adopted by the NERC Board of Trustees or as otherwise provided for in that jurisdiction.

Compliance shall be implemented over a 4-year period as described in the Implementation Plan.

Version History

Version	Date	Action	Change Tracking
1	TBD	Project 2013-03 (Phase 2)	N/A

Definitions of Terms Used in Standard

This section includes all newly defined or revised terms used in the proposed standard. Terms already defined in the Reliability Standards Glossary of Terms are not repeated here. New or revised definitions listed below become approved when the proposed standard is approved. When the standard becomes effective, these defined terms will be removed from the individual standard and added to the Glossary.

Geomagnetic Disturbance Vulnerability Assessment or GMD Vulnerability Assessment: Documented evaluation of potential susceptibility to voltage collapse, Cascading, or localized damage of equipment due to geomagnetic disturbances.

A. Introduction

1. **Title:** Transmission System Planned Performance for Geomagnetic Disturbance Events
2. **Number:** TPL-007-1
3. **Purpose:** Establish requirements for Transmission system planned performance during geomagnetic disturbance (GMD) events ~~within the Near-Term Transmission Planning Horizon.~~

4. **Applicability:**

- 4.1. **Functional Entities:**

- 4.1.1 Planning Coordinator with a ~~Planning Coordinator~~planning area that includes a ~~power transformer with a high side, wye-grounded winding connected at 200 kV~~Facility or ~~higher~~Facilities specified in 4.2;

- 4.1.2 Transmission Planner with a ~~Transmission Planning~~planning area that includes a ~~power transformer with a high side, wye-grounded winding connected at 200 kV~~Facility or ~~higher~~Facilities specified in 4.2;

- 4.1.3 Transmission Owner who owns a Facility or Facilities specified in 4.2;

- 4.1.4 Generator Owner who owns a Facility or Facilities specified in 4.2.

- 4.2. Facilities:

- 4.1.34.2.1 Facilities that include power transformer(s) with ~~a~~ high side, wye-grounded winding ~~connected at~~with terminal voltage greater than 200 kV ~~or higher.~~

- ~~Generation Owner who owns a power transformer(s) with a high side, wye-grounded winding connected at 200 kV or higher~~

Rationale: Instrumentation transformers and station service transformers do not have significant impact on GIC flows; therefore, they are not included in the applicability for this standard.

5. **Background:**

During a GMD event, geomagnetically-induced currents (GIC) may cause transformer hot-spot heating or damage, loss of Reactive Power sources, increased Reactive Power demand, and Misoperation, the combination of which may result in voltage collapse and blackout.

B. Requirements and Measures

- R1. Each Planning Coordinator ~~and, in conjunction with each of its~~ Transmission ~~Planner shall maintain ac System models and geomagnetically-induced current (GIC) System~~

~~models within its respective area for~~ Planners, shall identify the individual and joint responsibilities of the Planning Coordinator and each of the Transmission Planners in the Planning Coordinator's planning area for maintaining models and performing the studies needed to complete its GMD Vulnerability Assessment. ~~The models shall use data consistent with that provided in accordance with the MOD standards, supplemented by other sources as needed, including items represented in the Corrective Action Plan, and shall represent projected System conditions. This establishes Category P8 as the normal System condition for GMD planning in Table 1. The System models shall include:~~(s).
[Violation Risk Factor: ~~Medium~~Low] [Time Horizon: Long-term Planning]

~~1.1. Existing Facilities~~

~~1.2. Known outage(s) of generation or Transmission Facility(ies) with a duration of at least six months.~~

~~1.3. New planned Facilities and changes to existing Facilities~~

~~1.4. Real and reactive Load forecasts~~

~~1.5. Known commitments for Firm Transmission Service and Interchange~~

~~1.6. Resources (supply or demand side) required for Load~~

M1. ~~Each Planning Coordinator and Transmission Planner, in conjunction with each of its Transmission Planners, shall provide documentation on roles and responsibilities, such as meeting minutes, agreements, and email correspondence that identifies that agreement has been reached on individual and joint responsibilities for maintaining models and performing the studies needed to complete GMD Vulnerability Assessment(s) in accordance with Requirement R1.~~

R2. ~~Responsible entities as determined in Requirement R1 shall maintain System models and geomagnetically-induced current (GIC) System models of the responsible entity's planning area for performing the studies needed to complete GMD Vulnerability Assessment(s). [Violation Risk Factor: Medium] [Time Horizon: Long-term Planning]~~

M2. ~~Responsible entities as determined in Requirement R1 shall have evidence in either electronic or hard copy format that it is maintaining ~~ae~~ System models and geomagnetically-induced current (GIC) System models ~~within its respective area, using data consistent with MOD standards including items represented in the Corrective Action Plan, representing projected System conditions, and that the models represent the required information in accordance with Requirement R1, of the responsible entity's~~ planning area for performing the studies needed to complete GMD Vulnerability Assessment(s).~~

Rationale for Requirement ~~R1~~R2:

A GMD Vulnerability Assessment requires a ~~de~~ GIC System model to calculate GIC flow which is used to determine transformer Reactive Power absorption and transformer thermal response. ~~Details~~Guidance for developing the GIC System model are provided in the GIC Application Guide developed by the NERC GMD Task Force and available

at: http://www.nerc.com/comm/PC/Geomagnetic%20Disturbance%20Task%20Force%20GMDTF%202013/GIC%20Application%20Guide%202013_approved.pdf

The ~~ae~~-System model specified in Requirement R2 is used in conducting steady -state power flow analysis that accounts for the Reactive Power absorption of transformers due to GIC in the System.

The projected System condition for GMD planning may include adjustments to ~~posture~~ the System that are executable in response to space weather information. These adjustments could include recalling or postponing maintenance outages, for example.

~~R2.R3. R2.~~ Each Planning Coordinator and Transmission Planner ~~Responsible entities as determined in Requirement R1~~ shall complete a GMD Vulnerability Assessment of the Near-Term Transmission Planning Horizon ~~for its respective area~~ once every 60 calendar months. This GMD Vulnerability Assessment shall use studies based on models identified in Requirement R2, document assumptions, and document summarized results of the steady state analysis. [*Violation Risk Factor: High*] [*Time Horizon: Long-term Planning*]

3.1. Studies shall include the following conditions:

3.1.1. System peak Load for at least one year within the Near-~~t~~Term Transmission Planning Horizon;

3.1.2. System Off-Peak Load for at least one year within the Near-~~t~~Term Transmission Planning Horizon.

3.2. Studies shall be conducted based on the benchmark GMD event described in Attachment 1 to determine whether the system meets the performance requirements in Table 1.

~~3.3. M2.~~ The GMD Vulnerability Assessment shall be provided within 90 days of completion to the responsible entity's Reliability Coordinator and, adjacent Planning Coordinators, adjacent Transmission Planner ~~Planners, and to any functional entity that submits a written request and has a reliability related need.~~

3.3.1 If a recipient of the GMD Vulnerability Assessment provides documented comments on the results, the responsible entity shall provide a documented response to that recipient within 90 calendar days of receipt of those comments.

M3. Responsible entities as determined in Requirement R1 shall have dated evidence such as electronic or hard copies of its GMD Vulnerability Assessment meeting all of the requirements in Requirement ~~R2-R3~~. Responsible entities as determined in Requirement R1 shall also provide evidence, such as email records, web postings with an electronic notice of posting, or postal receipts showing recipient and date, that it has distributed its GMD Vulnerability Assessment within 90 calendar days of its completion to its Reliability Coordinator, adjacent Planning Coordinators, adjacent Transmission Planners,

and to any functional entity who has indicated a reliability related need as specified in Requirement R3. Responsible entities as determined in Requirement R1 shall also provide evidence, such as email notices or postal receipts showing recipient and date, that it has provided a documented response to comments received on its GMD Vulnerability Assessment within 90 calendar days of receipt of those comments in accordance with Requirement R3.

Rationale for Requirement ~~R2~~R3:

The GMD Vulnerability Assessment includes steady -state power flow analysis and supporting studies using the models specified in Requirement R2 that account for the effects of GIC. Performance criteria are specified in Table 1.

System peak Load and Off-peak Load must be examined in the analysis.

Distribution of GMD Vulnerability Assessment results provides a means for sharing relevant information with other entities responsible for planning reliability. Results of GIC studies may affect neighboring systems and should be taken into account by planners.

The GMD Planning Guide developed by the NERC GMD Task Force provides technical information on GMD-specific considerations for planning studies. It is available at:

http://www.nerc.com/comm/PC/Geomagnetic%20Disturbance%20Task%20Force%20GMDTF%202013/GMD%20Planning%20Guide_approved.pdf

R4. Each Responsible entities as determined in Requirement R1 shall have criteria for acceptable System steady state voltage limits for its System during the benchmark GMD event described in Attachment 1. [Violation Risk Factor: Medium] [Time Horizon: Long-term Planning-Coordinator and]

M4. Responsible entities as determined in Requirement R1 shall have evidence such as electronic or hard copies of the criteria for acceptable System steady state voltage limits for its System in accordance with Requirement R4.

Rationale for Requirement R4:

System steady state voltage limits for GMD Vulnerability Assessment may be different from the limits used in the TPL-001 Planning Assessment. The planner must adhere to established limits that ensure the planned System achieves the performance requirements in Table 1.

R5. Responsible entities as determined in Requirement R1 shall provide geomagnetically-induced current (GIC) flow information to be used for the transformer thermal impact assessment specified in Requirement R6 to each Transmission Planner that determines Owner and Generator Owner in the planning area that owns an applicable power transformer. The GIC flow information shall include for each applicable power transformer: [Violation Risk Factor: Medium] [Time Horizon: Long-term Planning]

5.1 Maximum effective GIC value for the worst case geoelectric field orientation for the benchmark GMD event described in Attachment 1; and

5.2 Effective GIC time series, GIC(t), calculated using the benchmark GMD event described in Attachment 1 for each applicable power transformer where the Maximum effective GIC value for the worst case geoelectric field orientation exceeds 15 Amperes per phase.

M5. Responsible entities as determined in Requirement R1 shall provide evidence, such as email records, web postings with an electronic notice of posting, or postal receipts showing recipient and date, that it has provided geomagnetically-induced current (GIC) flow information to each Transmission Owner and Generator Owner that owns an applicable power transformer as specified in Requirement R5.

Rationale for Requirement R5:

This GIC information is necessary for determining the thermal impact of GIC on transformers in the planning area and must be provided to entities responsible for performing the thermal impact assessment so that they can accurately perform the assessment.

The GIC flows provided in part 5.1 are used to screen the transformer fleet such that only those transformers that experience an effective GIC flow of 15A or greater are evaluated.

The GIC flows provided by part 5.2 and 5.3 are used to convert the steady-state GIC flows to time-series GIC data used for transformer thermal impact assessment. Additional guidance is available in the Thermal Impact Assessment white paper:

<http://www.nerc.com/pa/Stand/Pages/Project-2013-03-Geomagnetic-Disturbance-Mitigation.aspx>

R6. Each Transmission Owner and Generator Owner shall conduct a thermal impact assessment for each of its solely and jointly owned applicable power transformers where the maximum effective geomagnetically-induced current (GIC) value provided in Requirement R5 part 5.1 is 15 Amperes or greater per phase. The thermal impact assessment shall: [Violation Risk Factor: High] [Time Horizon: Long-term Planning]

6.1. Be based on the effective GIC flow information provided in Requirement R5; and

6.2. Document assumptions used in the analysis; and

6.3. Describe suggested actions and supporting analysis to mitigate the impact of GICs, if any; and

6.4. Be performed and provided to the responsible entities as determined in Requirement R1 within 12 calendar months of receiving GIC flow information specified in Requirement R5.

M6. Each Transmission Owner and Generator Owner shall have evidence such as electronic or hard copies of its thermal impact assessment for all of its applicable solely and jointly owned power transformers where maximum effective geomagnetically-induced current (GIC) value provided in Requirement R5 part 5.1 is 15 Amperes or greater per phase as specified in Requirement R6.

Rationale for Requirement R6:

The thermal impact assessment may be based on manufacturer-provided GIC capability curves, thermal response simulation, or other technically justified means. A process for conducting the assessment is presented in the Transformer Thermal Impact Assessment white paper posted on the project page.

<http://www.nerc.com/pa/Stand/Pages/Project-2013-03-Geomagnetic-Disturbance-Mitigation.aspx>

~~R3.R7.~~ Responsible entities as determined in Requirement R1 that conclude through the GMD Vulnerability Assessment conducted in Requirement ~~R2R3~~ that ~~itstheir~~ System does not meet the performance requirements of Table 1 shall develop a Corrective Action Plan addressing how the performance requirements will be met. The Corrective Action Plan shall: [Violation Risk Factor: High] [Time Horizon: Long-term Planning]

~~3.1.7.1.~~ List System deficiencies and the associated actions needed to achieve required System performance. Examples of such actions include:

- Installation, modification, retirement, or removal of Transmission and generation Facilities and any associated equipment.
- Installation, modification, or removal of Protection Systems or Special Protection Systems.
- Use of Operating Procedures specifying how long they will be needed as part of the Corrective Action Plan.
- Use of Demand-Side Management, new technologies, or other initiatives.

~~8.1.~~ Be reviewed in subsequent GMD Vulnerability Assessments ~~for continued validity and implementation status of identified~~ until it is determined that the System ~~Facilities and Operating Procedures.~~

~~M3.~~ Each Planning Coordinator and Transmission Planner shall have evidence such as electronic or hard copies of its Corrective Action Plan as specified in Requirement R3.

~~R4.~~ Each Planning Coordinator and Transmission Planner shall have criteria for acceptable System steady state voltage limits for its System during the GMD conditions described in Attachment 1. [Violation Risk Factor: Medium] [Time Horizon: Long-term Planning]

~~3.2.7.2.~~ M4. ~~Each Planning Coordinator and Transmission Planner shall have evidence such as electronic or hard copies of~~ meets the criteria for acceptable System steady state voltage limits for its System in accordance with Requirement R4 performance requirements contained in Table 1.

Rationale for Requirement R4:

System steady state voltage limits for GMD Vulnerability Assessment may be different from the limits used in the TPL-001 Planning Assessment. The planner must adhere to established limits that ensure the planned System achieves the performance requirements in Table 1.

~~R5.~~ Each Planning Coordinator, in conjunction with each of its Transmission Planners, shall determine and identify the individual and joint responsibilities of entities in the Planning Coordinator's area for performing the required studies for the GMD Vulnerability Assessment. *[Violation Risk Factor: Low] [Time Horizon: Long-term Planning]*

~~M5.~~ Each Planning Coordinator, in conjunction with each of its Transmission Planners, shall provide documentation on roles and responsibilities, such as meeting minutes, agreements, and e-mail correspondence that identifies that agreement has been reached on individual and joint responsibilities for performing the required studies for the GMD Vulnerability Assessment in accordance with Requirement R5.

~~3.3.7.3. R6.~~ Each Planning Coordinator and Transmission Planner shall distribute its GMD Vulnerability Assessment results and Corrective Action Plan, if any, ~~to~~Be provided within 90 days of completion to the responsible entity's Reliability Coordinator, adjacent Planning Coordinators, adjacent Transmission Planners, and ~~Transmission Owners and Generator Owners in its respective planning area as specified in the Applicability Section 4.1.3 and 4.1.4 within 90 calendar days of completion, and to any functional entity that submits a written request and~~ has a reliability related need ~~and submits a written request for the information within 30 days of such a request.~~ *[Violation Risk Factor: Medium] [Time Horizon: Long-term Planning]*.

~~3.3.1.7.3.1. 6.1~~ — If a recipient of the GMD Vulnerability Assessment results Corrective Action Plan provides documented comments on the results, the respective ~~Planning Coordinator or Transmission Planner~~responsible entity shall provide a documented response to that recipient within 90 calendar days of receipt of those comments.

~~M6.~~ Each Planning Coordinator and Transmission Planner shall provide evidence, such as email notices~~M7.~~ Responsible entities as determined in Requirement R1 that conclude through the GMD Vulnerability Assessment conducted in Requirement R3 that the responsible entity's System does not meet the performance requirements of Table 1 shall have evidence such as electronic or hard copies of its Corrective Action Plan as specified in Requirement R7. Responsible entities as determined in Requirement R1 shall also provide evidence, such as email records, web postings with an electronic notice of posting, or postal receipts showing recipient and date, that it has distributed its ~~GMD Vulnerability Assessment results and Corrective Action Plan, if any, to~~within 90 calendar days of its completion to its Reliability Coordinator, adjacent Planning Coordinators ~~and~~, adjacent Transmission Planners ~~within 90 days of completion~~, and to any functional entity who has indicated a reliability related need ~~within 30 days of a written request.~~ Each Planning Coordinator and Transmission Planner as specified in Requirement R7. Responsible entities as determined in Requirement R1 shall also provide evidence, such as email notices or postal receipts showing recipient and date, that it has provided a documented response to comments received on its ~~GMD Vulnerability Assessment results~~Corrective Action Plan within 90 calendar days of receipt of those comments in accordance with Requirement ~~R5~~R7.

Rationale for Requirement R6:

~~Distribution of GMD Vulnerability Assessment results and Corrective Action Plans provides a means for sharing relevant information with other entities responsible for planning reliability. Results of GIC studies and planned mitigation measures may affect neighboring systems and should be taken into account by planners. Additionally, this GIC information is essential for determining the thermal impact of GIC on transformers in the planning area and must be provided to entities responsible for performing the thermal impact assessment.~~

~~**R7.** Each Transmission Owner and Generator Owner shall conduct an assessment of thermal impact for all of its solely and jointly owned power transformers with high-side, wye-grounded windings connected at 200 kV or higher. The assessment shall: *[Violation Risk Factor: High] [Time Horizon: Long-term Planning]*~~

~~**6.1.** Be based on the benchmark GMD event described in Attachment 1 with peak geomagnetically-induced current (GIC) flows as modeled in the steady-state analysis conducted in Requirement R2~~

~~**6.2.** Document assumptions used in the analysis~~

~~**6.3.** Describe suggested actions and supporting analysis to mitigate the impact of geomagnetically-induced currents, if any.~~

~~**M7.** Each Transmission Owner and Generator Owner shall have evidence such as electronic or hard copies of its assessment of thermal impact for all of its solely and jointly owned power transformers with high-side, wye-grounded windings connected at 200 kV or higher as specified in Requirement R7.~~

~~Rationale for Requirement R7:~~

~~The thermal impact assessment may be based on manufacturer-provided GIC capability curves, thermal response simulation, or other technically justified means. A process for conducting the assessment is presented in the whitepaper posted on the project page.~~

~~http://www.nerc.com/pa/Stand/Pages/Project_2013_03_Geomagnetic_Disturbance_Mitigation.aspx~~

~~**R8.** Each Transmission Owner and Generator Owner shall provide its assessment of thermal impact specified in Requirement R7 for all of its solely and jointly owned power transformers with high-side, wye-grounded windings connected at 200 kV or higher within 90 days of completion to the Planning Coordinator and Transmission Planner with responsibility for the area in which the associated power transformer is located. *[Violation Risk Factor: Medium] [Time Horizon: Long-term Planning]*~~

~~**M8.** Each Transmission Owner and Generator Owner shall have dated evidence such as postal receipts or email confirmation that it has provided a copy of its assessment of thermal impact for all of its solely and jointly owned power transformers with high-side, wye-grounded wye windings connected at 200 kV or higher as specified in Requirement R7 to the Planning Coordinator and Transmission Planner with responsibility for the area in which the associated power transformer is located within the timeframe prescribed in Requirement R8.~~

Table 1 –Steady State Planning Events				
<p>Steady State:</p> <ul style="list-style-type: none"> a. The System shall remain stable.Voltage collapse. Cascading and uncontrolled islanding shall not occur. b. Consequential Load Loss as well as generation loss is acceptable as a consequence of P8<u>the</u> planning event. c. Planned System adjustments such as Transmission configuration changes and re-dispatch of generation are allowed if such adjustments are executable within the time duration applicable to the Facility Ratings. d. System steady state voltages shall be within acceptable limits as established by the Planning Coordinator and the Transmission Planner in accordance with Requirement R4. 				
Category	Initial Condition	Event	Interruption of Firm Transmission Service Allowed	Non-Consequential Load Loss Allowed
P8 <u>GMD</u> GMD Event with Outages	1. System as may be postured in response to space weather information ¹ , and then 2. GMD event ²	Reactive Power compensation devices and other Transmission Facilities removed as a result of Protection System operation during the GMD event ³	Yes ⁴	Yes ⁴

Table 1 – Steady State Performance Footnotes
<ol style="list-style-type: none"> 1. The System condition for GMD planning may include adjustments to posture the System that are executable in response to space weather information. 2. The GMD conditions for <u>the</u> planning event-P8 are described in Attachment 1 (Benchmark GMD Event). 3. Protection Systems may trip due to the effects of harmonics. P8<u>GMD</u> planning analysis shall consider removal of equipment that the planner determines may be susceptible. 4. The objective of the GMD Vulnerability Assessment is to prevent instability, uncontrolled separation, Cascading and uncontrolled islanding of the System during a GMD event. Non-Consequential Load Loss<u>Load loss</u> and/or curtailment of Firm Transmission Service may be needed to meet BES performance requirements during studied GMD conditions but should not be used as the primary method of achieving required performance. GMD Operating Procedures should be based on predetermined triggers from studied GMD conditions so that the likelihood and magnitude of Non-Consequential Load Loss or curtailment of Firm Transmission Service is minimized during a GMD event.

Attachment 1

Calculating Geoelectric Fields for the Benchmark GMD Event

The benchmark GMD event¹ defines the geoelectric field values used to compute geomagnetically-induced current (GIC) flows that are needed to conduct a GMD Vulnerability Assessment. It is composed of the following elements: (1) a reference peak geoelectric field amplitude of 8 V/km derived from statistical analysis of historical magnetometer data; (2) scaling factors to account for local geomagnetic latitude; (3) scaling factors to account for local earth conductivity; and (4) a reference geomagnetic field time series or waveshape to facilitate time-domain analysis of GMD impact on equipment.

The regional geoelectric field peak amplitude to be used in GMD Vulnerability Assessment, E_{peak} , can be obtained from the reference geoelectric field value of 8 V/km using the following relationship

$$E_{\text{peak}} = 8 \times \alpha \times \beta \text{ (V/km)}$$

where α is the scaling factor to account for local geomagnetic latitude, and β is a scaling factor to account for the local earth conductivity structure.

Scaling the Geomagnetic Field

The benchmark GMD event is defined for geomagnetic latitude of 60° and it must be scaled to account for regional differences based on geomagnetic latitude. Table ~~4-12~~ provides a scaling factor correlating peak geoelectric field to geomagnetic latitude. Alternatively, the scaling factor α can be computed with the empirical expression

$$\alpha = 0.001 \cdot e^{(0.115 \cdot L)} \quad \alpha = 0.001 \cdot e^{(0.115 \cdot L)}$$

where L is the geomagnetic latitude in degrees and $0.1 \leq \alpha \leq 1$

For large planning areas that cover more than one scaling factor from Table 2, the most conservative (largest) value for α should be used in scaling the geomagnetic field. Alternatively, a planner could use a tool that is capable of performing analysis using a non-uniform or piecewise uniform geomagnetic field.

¹ The benchmark GMD event description is available on the Project 2013-03 Geomagnetic Disturbance Mitigation project page: <http://www.nerc.com/pa/Stand/Pages/Project-2013-03-Geomagnetic-Disturbance-Mitigation.aspx>

Table 1-12: Geomagnetic Field Scaling Factors

Geomagnetic Latitude (Degrees)	Scaling Factor1 (α)
≤ 40	0.10
45	0.2
50	0.3
55 <u>54</u>	0.6 <u>0.65</u>
56	0.6
57	0.7
58	0.8
59	0.9
≥ 60	1.0

Scaling the Goelectric Field

The benchmark GMD event is defined for the reference Quebec earth model described in Table 1-34. The peak goelectric field, E_{peak} , to be used in a GMD Vulnerability Assessment may be obtained by either

- Calculating the goelectric field for the ground conductivity in the planning area and the reference geomagnetic field time series scaled according to geomagnetic latitude, using a procedure such as the plane wave method described in the NERC GMD Task Force GIC Application Guide²; or
- Using the earth conductivity scaling factor β from Table 1-23 that correlates to the ground conductivity map in Figure 1-4 or Figure 1-2. Along with the scaling factor α , β is applied to the reference goelectric field using the following equation to obtain the regional goelectric field peak amplitude E_{peak} to be used in GMD Vulnerability Assessment. When a ground conductivity model is not available the planning entity should use a β factor of 1 or a technically-justified value.

$$E_{\text{peak}} = 8 \times \alpha \times \beta \text{ (V/km)}$$

The earth models used to calculate Table 1-23 for the United States were obtained from publicly available magnetotelluric data that is published on the U. S. Geological Survey website³. The models used to calculate Table 1-23 for Canada were obtained from Natural Resources Canada (NRCan) and reflect the average structure for large regions. NRCan also has developed some models for sub-regions which should be used when available. Because all models in Table 1-23 are approximations, a planner can substitute a technically justified earth model for its planning area when available.

² Available at the NERC GMD Task Force project page:
[http://www.nerc.com/comm/PC/Pages/Geomagnetic-Disturbance-Task-Force-\(GMDTF\)-2013.aspx](http://www.nerc.com/comm/PC/Pages/Geomagnetic-Disturbance-Task-Force-(GMDTF)-2013.aspx)

³ Available at <http://geomag.usgs.gov/conductivity/>

TPL-007-1 — Transmission System Planned Performance Duringfor Geomagnetic DisturbancesDisturbance Events

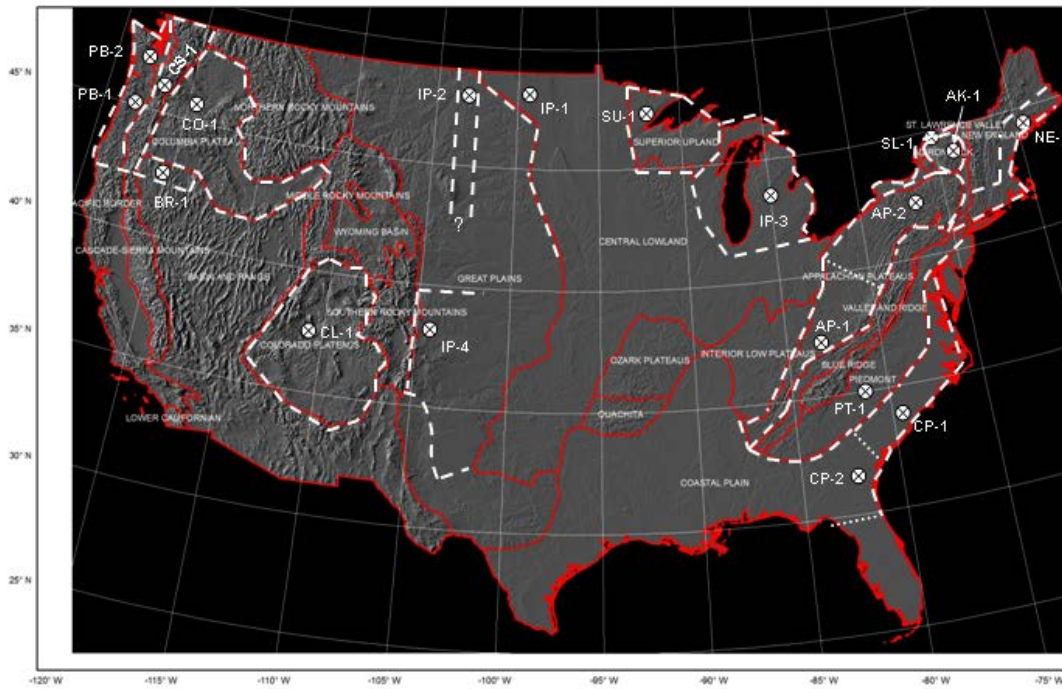

For large planning areas that cover more than one scaling factor from Table 3, the most conservative (largest) value for β should be used in scaling the geoelectric field. Alternatively, a planner could use a tool that is capable of performing analysis using a non-uniform or piecewise uniform geoelectric field.

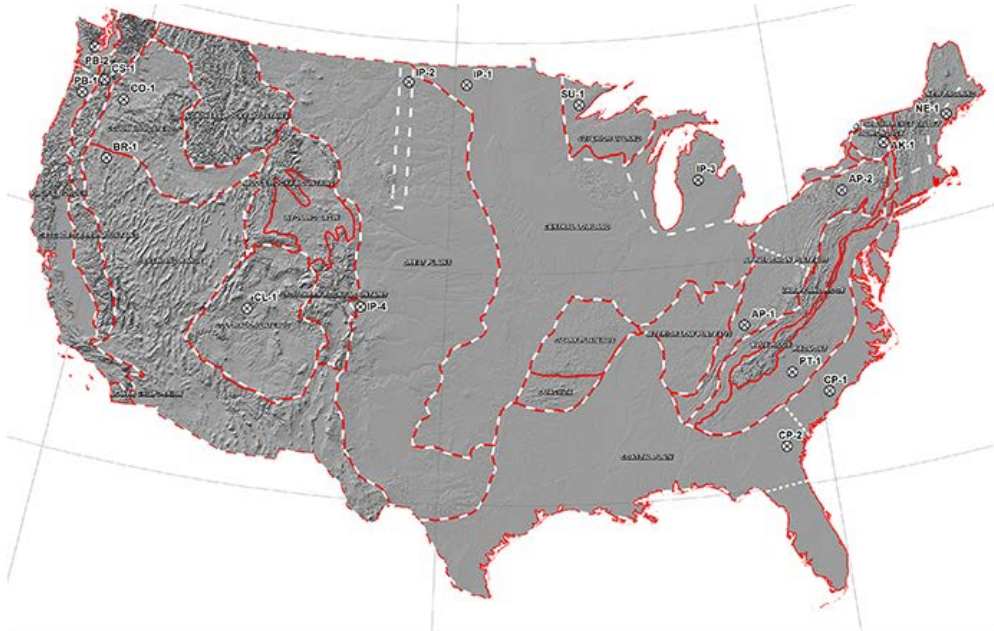

Figure 1-1: Physiographic Regions of the Continental United States⁴



Figure 1-2: Physiographic Regions of Canada

⁴ Additional map detail is available at the U.S. Geological Survey (<http://geomag.usgs.gov/>)

Table 1-23 Geoelectric Field Scaling Factors

USGS Earth model	Scaling Factor (β)
AK1A	0.56
AK1B	.056
AP1	0.33
AP2	0.82
BR1	0.22
CL1	0.76
CO1	0.27
CP1	0.81
CP2	0.95
CS1	0.41
IP1	0.94
IP2	0.28
IP3	0.93
IP4	0.41
NE1	0.81
PB1	0.62
PB2	0.46
PT1	1.17
SL1	0.53
SU1	0.93
BOU	0.28
FBK	0.56
PRU	0.21
BC	0.67
PRAIRIES	0.96
SHIELD	1.0
ATLANTIC	0.79

Table 1-34: Reference Earth Model (Quebec)

Layer Thickness (km)	Resistivity (Ω -m)
15	20,000
10	200
125	1,000
200	100
∞	3

Reference Geomagnetic Field Time Series or Waveshape⁵

The geomagnetic field measurement record of the March 13-14 1989 GMD event, measured at NRCan's Ottawa geomagnetic observatory is the basis for the reference geomagnetic field waveshape to be used when performing thermal analysis of power transformers to calculate the GIC time series, GIC(t), required for transformer thermal impact assessment.

The geomagnetic latitude of the Ottawa geomagnetic observatory is 55°; therefore, the amplitude of the geomagnetic field measurement data were scaled up to the 60° reference geomagnetic latitude (see Figure 1-3) such that the resulting peak geoelectric field amplitude computed using the reference earth model was 8 V/km (see Figs. 1-4 and 1-5). Sampling rate for the geomagnetic field waveshape is 10 seconds.⁶ To use this geoelectric field time series where a different earth model is applicable, it should be scaled with the appropriate conductivity scaling factor β .

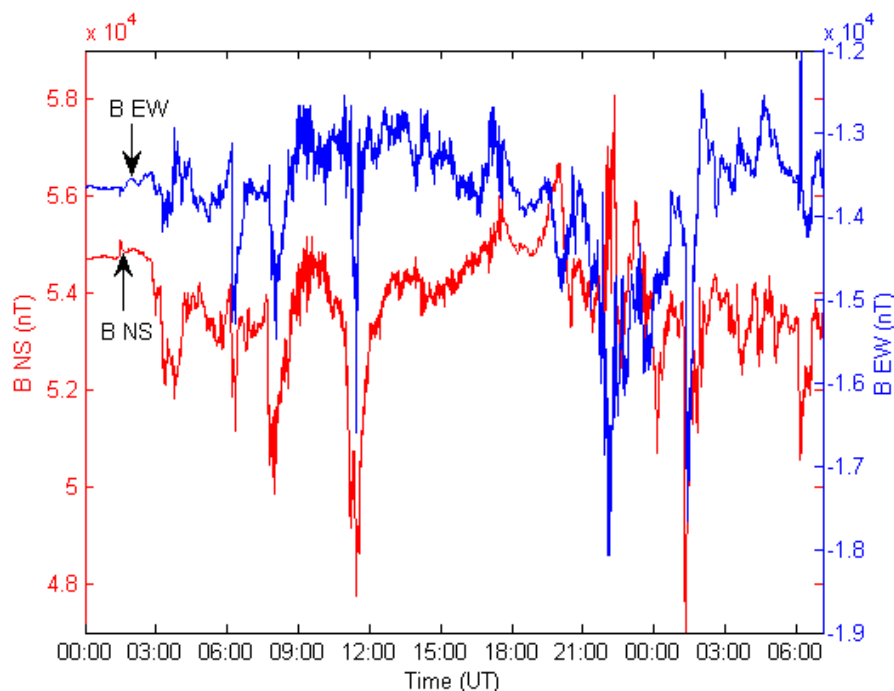

⁵ Refer to the Benchmark GMD Event Description for details on the determination of the reference geomagnetic field waveshape: <http://www.nerc.com/pa/Stand/Pages/Project-2013-03-Geomagnetic-Disturbance-Mitigation.aspx>

⁶ The data file of the benchmark geomagnetic field waveshape is available on the NERC GMD Task Force project page: [http://www.nerc.com/comm/PC/Pages/Geomagnetic-Disturbance-Task-Force-\(GMDTF\)-2013.aspx](http://www.nerc.com/comm/PC/Pages/Geomagnetic-Disturbance-Task-Force-(GMDTF)-2013.aspx)

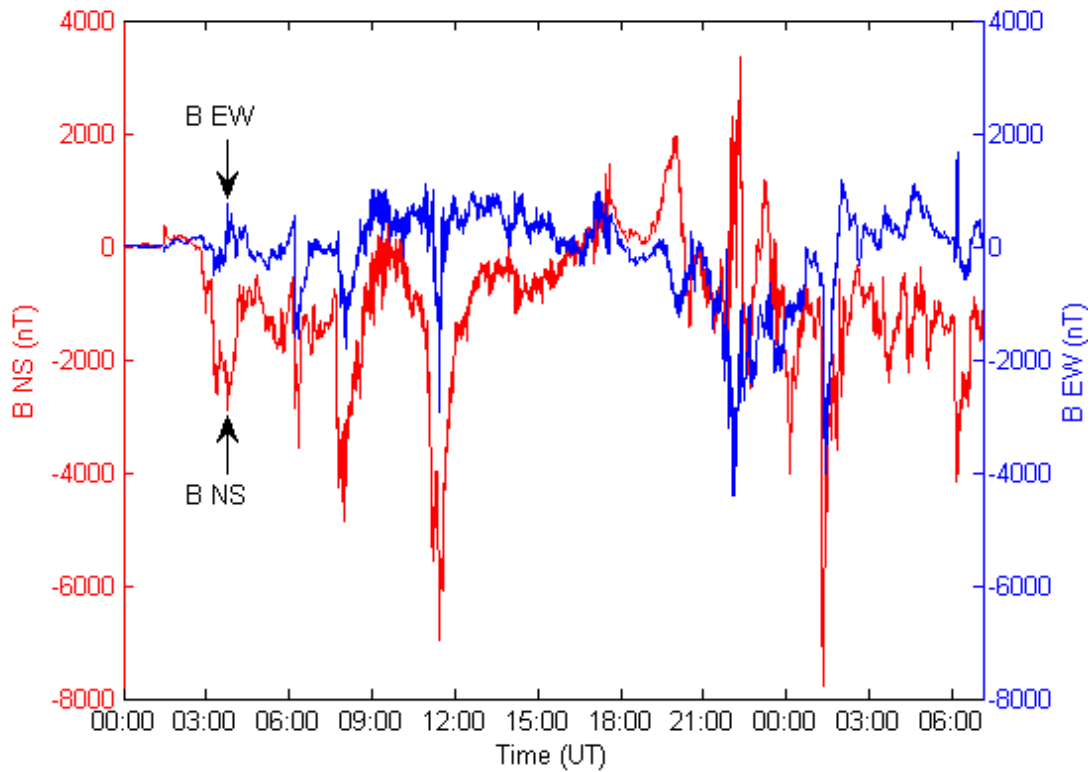

Figure 1-3: Benchmark Geomagnetic Field Waveshape. Red B_n (Northward), Blue B_e (Eastward)

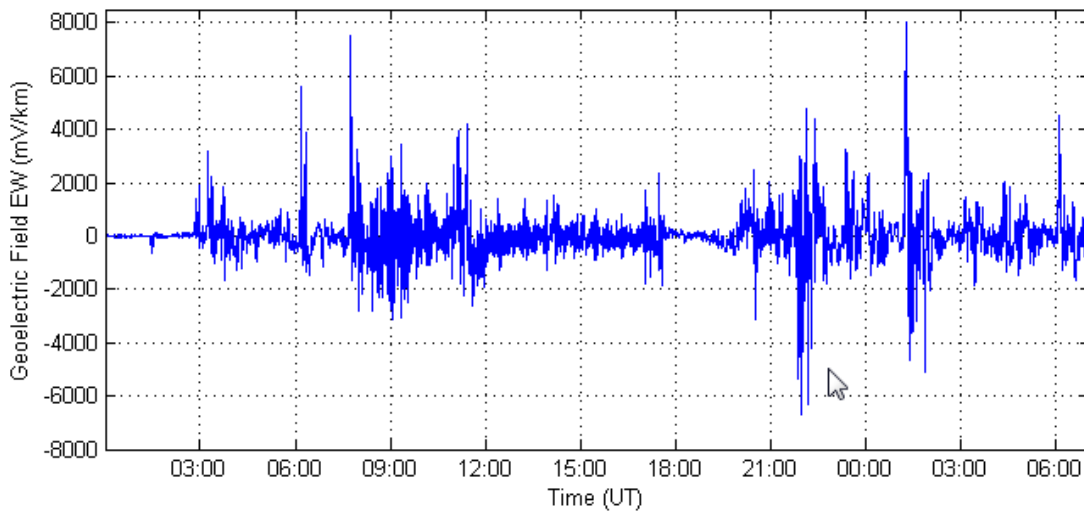
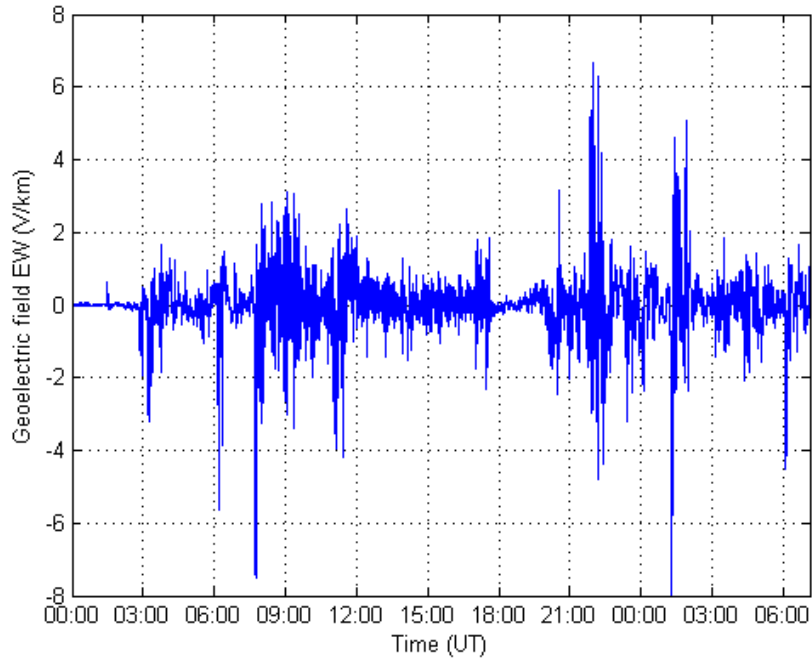

Figure 1-4: Benchmark Geoelectric Field Waveshape - E_E (Eastward)

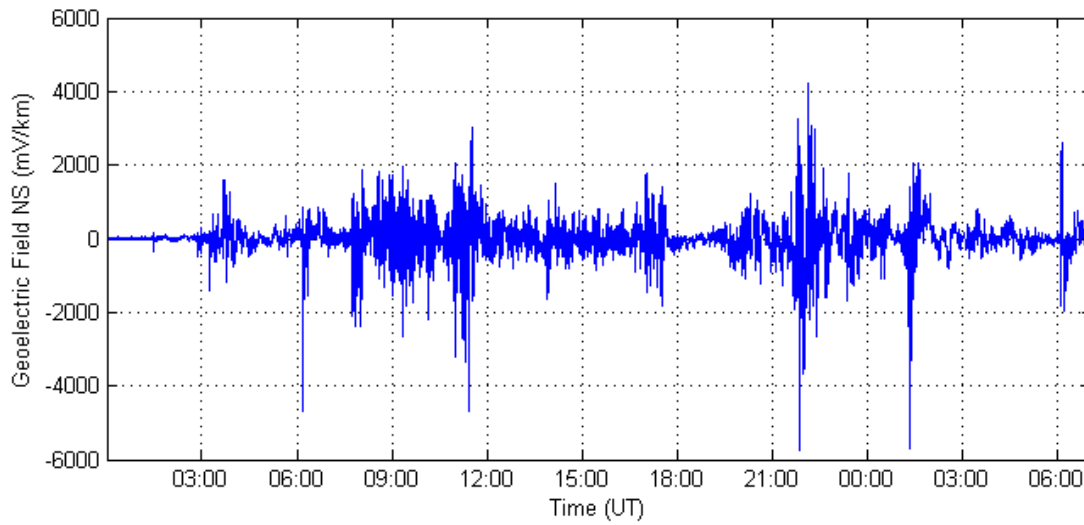
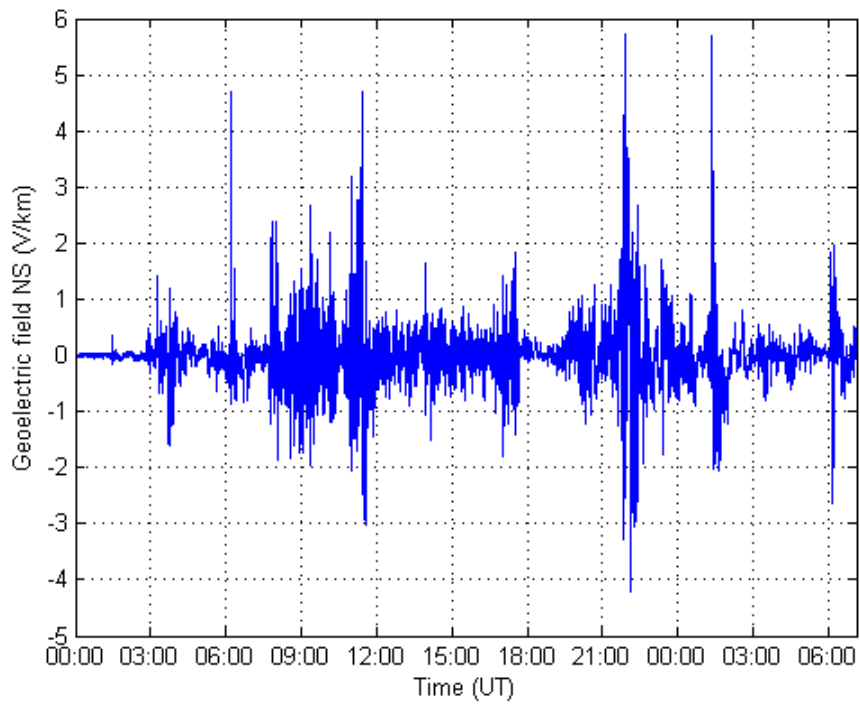

Figure 1-5: Benchmark Geoelectric Field Waveshape – E_N (Northward)

1. Compliance Monitoring Process

1.1. Compliance Enforcement Authority

As defined in the NERC Rules of Procedure, “Compliance Enforcement Authority” means NERC or the Regional Entity in their respective roles of monitoring and enforcing compliance with the NERC Reliability Standards

1.2. Evidence Retention

The following evidence retention periods identify the period of time an entity is required to retain specific evidence to demonstrate compliance. For instances where the evidence retention period specified below is shorter than the time since the last audit, the CEA may ask an entity to provide other evidence to show that it was compliant for the full time period since the last audit.

The Planning Coordinator, Transmission Planner, Transmission Owner, and Generator Owner shall keep data or evidence to show compliance as identified below unless directed by its Compliance Enforcement Authority to retain specific evidence for a longer period of time as part of an investigation:

The responsible entities shall retain documentation as evidence for five years.

If a Planning Coordinator, Transmission Planner, Transmission Owner, or Generator Owner is found non-compliant, it shall keep information related to the non-compliance until mitigation is complete and approved or for the time specified above, whichever is longer.

The Compliance Enforcement Authority shall keep the last audit records and all requested and submitted subsequent audit records.

1.3. Compliance Monitoring and Assessment Processes:

Compliance Audits

Self-Certifications

Spot Checking

Compliance Violation Investigations

Self-Reporting

Complaints Text

1.4. Additional Compliance Information

None

Table of Compliance Elements

R #	Time Horizon	VRF	Violation Severity Levels			
			Lower VSL	Moderate VSL	High VSL	Severe VSL
<u>R1</u>	<u>Long-term Planning</u>	<u>Low</u>	<u>N/A</u>	<u>N/A</u>	<u>N/A</u>	<u>The Planning Coordinator, in conjunction with each of its Transmission Planners, failed to determine and identify individual or joint responsibilities of the Planning Coordinator and each of the Transmission Planners in the Planning Coordinator’s planning area for maintaining models and performing the studies needed to complete GMD Vulnerability Assessment(s).</u>
R1 <u>R2</u>	Long-term Planning	Medium	The responsible entity’s ac-System model and geomagnetically-induced current (GIC) model failed to include one of the elements in Requirement R1, Parts 1.1 through 1.6. <u>N/A</u>	The responsible entity’s ac-System model and geomagnetically-induced current (GIC) model failed to include two of the elements in Requirement R1, Parts 1.1 through 1.6. <u>N/A</u>	The responsible entity’s ac-System model and geomagnetically-induced current (GIC) model failed to include three of the elements in Requirement R1, Parts 1.1 through 1.6. <u>N/A</u>	The responsible entity’s ac-System model and geomagnetically-induced current (GIC) model failed to include four or more System models of the elements in Requirement R1, Parts 1.1 through 1.6;

						<p>OR</p> <p>The responsible entity's ac System model and geomagnetically-induced current (GIC) model did not represent projected System conditions as described in Requirement R1;</p> <p>OR</p> <p>The responsible entity's ac System model and geomagnetically-induced current (GIC) model did not use data consistent with responsible entity's <u>planning area for performing the MOD standards including items represented in the Corrective Action Plan studies needed to complete GMD Vulnerability Assessment(s).</u></p>
R2 <u>R3</u>	Long-term Planning	High	The responsible entity completed a GMD Vulnerability Assessment but it was more than 60 calendar months and less than or equal to 64 calendar	The responsible entity completed a GMD Vulnerability Assessment but it was more than 64 calendar months and less than or equal to 68 calendar	The responsible entity's completed GMD Vulnerability Assessment failed to include one <u>satisfy two</u> of the following Parts <u>elements listed in</u>	The responsible entity's completed GMD Vulnerability Assessment failed to include two <u>satisfy three</u> of the following Parts <u>elements listed in</u>

TPL-007-1 — Transmission System Planned Performance ~~Duringfor~~ Geomagnetic ~~Disturbances~~Disturbance Events

			months since the last GMD Vulnerability Assessment.	months since the last GMD Vulnerability Assessment; <u>OR</u> <u>The responsible entity's completed GMD Vulnerability Assessment failed to satisfy one of elements listed in Requirement R3 Parts 3.1 through 3.3.</u>	Requirement R2: Part 2R3 Parts 3.1 or 2.2through 3.3; OR The responsible entity completed a GMD Vulnerability Assessment but it was more than 68 calendar months and less than or equal to 72 calendar months since the last GMD Vulnerability Assessment.	Requirement R2: Part 2R3 Parts 3.1 or 2.2through 3.3; OR The responsible entity completed a GMD Vulnerability Assessment but it was more than 72 calendar months since the last GMD Vulnerability Assessment; OR The responsible entity does not have a completed GMD Vulnerability Assessment.
<u>R4</u>	<u>Long-term Planning</u>	<u>Medium</u>	<u>N/A</u>	<u>N/A</u>	<u>N/A</u>	<u>The responsible entity did not have criteria for acceptable System steady state voltage limits for its System during the benchmark GMD event described in Attachment 1 as required.</u>
<u>R3R5</u>	Long-term Planning	<u>HighMedium</u>	N/A	N/A	The responsible entity's <u>Corrective Action Plan</u> entity failed to comply with <u>provide</u> one of the elements <u>listed</u> in Requirement R3R5 parts <u>35.1 to 5.2</u>	The responsible entity's <u>Corrective Action Plan</u> entity failed to comply with <u>provide</u> two of the elements <u>listed</u> in Requirement R3R5 parts <u>35.1 to 5.2</u>

					<p><u>to each Transmission Owner and 3.2Generator Owner in the planning area that owns an applicable power transformer.</u></p>	<p><u>to each Transmission Owner and 3.2Generator Owner in the planning area that owns an applicable power transformer;</u> OR The responsible entity did not have a Corrective Action Plan as required by<u>provide geomagnetically-induced current (GIC) flow information to be used for the transformer thermal impact assessment specified in Requirement R3R6 to each Transmission Owner and Generator Owner in the planning area that owns an applicable power transformer.</u></p>
R4	Long-term Planning	Medium	N/A	N/A	N/A	The responsible entity does not have criteria for acceptable System steady-state voltage limits for its System during the GMD conditions as required.
R5	Long-term Planning	Low	N/A	N/A	N/A	The Planning Coordinator, in conjunction with each of its Transmission Planners, failed to

						determine and identify individual or joint responsibilities for performing required studies.
R6	Long-term Planning	Medium <u>High</u>	The responsible entity distributed its GMD Vulnerability Assessment results and Corrective Action Plan, if any, to adjacent Planning Coordinators, adjacent Transmission Planners, and Transmission Owners and Generator Owners in its respective planning area as specified in the Applicability Section 4.1.3 and 4.1.4 but it was more than 90 days but less than or equal to 120 days following its completion; <u>The responsible entity failed to conduct an assessment of thermal impact for 5% or less of its solely owned and jointly owned applicable power transformers where the maximum effective geomagnetically-</u>	The responsible entity distributed its GMD Vulnerability Assessment results and Corrective Action Plan, if any, to adjacent Planning Coordinators, adjacent Transmission Planners, and Transmission Owners and Generator Owners in its respective planning area as specified in the Applicability Section 4.1.3 and 4.1.4 but it was more than 120 days but less than or equal to 130 days following its completion; <u>The responsible entity failed to conduct an assessment of thermal impact for more than 5% up to (and including) 10% of its solely owned and jointly owned applicable power transformers where the</u>	The responsible entity distributed its GMD Vulnerability Assessment results and Corrective Action Plan, if any, to adjacent Planning Coordinators, adjacent Transmission Planners, and Transmission Owners and Generator Owners in its respective planning area as specified in the Applicability Section 4.1.3 and 4.1.4 but it was more than 130 days but less than or equal to 140 days following its completion; <u>The responsible entity failed to conduct an assessment of thermal impact for more than 10% up to (and including) 15% of its solely owned and jointly owned applicable power transformers where the</u>	The responsible entity distributed its GMD Vulnerability Assessment results and Corrective Action Plan, if any, to adjacent Planning Coordinators, adjacent Transmission Planners, and Transmission Owners and Generator Owners in its respective planning area as specified in the Applicability Section 4.1.3 and 4.1.4 but it was more than 140 days following its completion; <u>The responsible entity failed to conduct an assessment of thermal impact for more than 15% of its solely owned and jointly owned applicable power transformers where the maximum effective geomagnetically-</u>

		<p><u>induced current (GIC) value provided in Requirement R5 part 5.1 is 15 Amperes or greater per phase ;</u> OR The responsible entity distributed<u>conducted an assessment of thermal impact of its GMD Vulnerability Assessment results</u><u>solely owned and Corrective Action Plan, if any, to functional entities having a reliability-related need who requested</u><u>jointly owned applicable power transformers where the information-maximum effective geomagnetically-induced current (GIC) value provided in writing</u><u>Requirement R5 part 5.1 is 15 Amperes or greater per phase but it was</u><u>did so more than 30 days but 12 calendar months and less than or equal to 40 days following the request</u><u>13 calendar months of receiving GIC flow</u></p>	<p><u>maximum effective geomagnetically-induced current (GIC) value provided in Requirement R5 part 5.1 is 15 Amperes or greater per phase;</u> OR The responsible entity distributed<u>conducted an assessment of thermal impact of its GMD Vulnerability Assessment results</u><u>solely owned and Corrective Action Plan, if any, to functional entities having a reliability-related need who requested</u><u>jointly owned applicable power transformers where the information-maximum effective geomagnetically-induced current (GIC) value provided in writing</u><u>Requirement R5 part 5.1 is 15 Amperes or greater per phase but it was</u><u>did so more than 40 days but 13 calendar months and less than or equal to 50 days following the request</u><u>14 calendar months of</u></p>	<p><u>maximum effective geomagnetically-induced current (GIC) value provided in Requirement R5 part 5.1 is 15 Amperes or greater per phase;</u> OR The responsible entity distributed<u>conducted an assessment of thermal impact of its GMD Vulnerability Assessment results</u><u>solely owned and Corrective Action Plan, if any, to functional entities having a reliability-related need who requested</u><u>jointly owned applicable power transformers where the information-maximum effective geomagnetically-induced current (GIC) value provided in writing</u><u>Requirement R5 part 5.1 is 15 Amperes or greater per phase but it was</u><u>did so more than 50 days but 14 calendar months and less than or equal to 60 days following the request</u><u>15 calendar months of</u></p>	<p><u>induced current (GIC) value provided in Requirement R5 part 5.1 is 15 Amperes or greater per phase;</u> OR The responsible entity did not distribute its GMD Vulnerability Assessment results and Corrective Action Plan, if any, to adjacent Planning Coordinators, adjacent Transmission Planners, and Transmission Owners and Generator Owners in its respective planning area as specified in the Applicability Section 4.1.3 and 4.1.4; <u>The responsible entity conducted an assessment of thermal impact of its solely owned and jointly owned applicable power transformers where the maximum effective geomagnetically-induced current (GIC) value provided in Requirement R5 part 5.1 is 15 Amperes or</u></p>
--	--	--	--	--	---

		<p>information specified in Requirement R5; OR The responsible entity provided a documented responsefailed to documented comments received from a recipientinclude one of its GMD Vulnerability Assessment results and Corrective Action Plan, but it was more than 30 days but less than or equal to 40 days following the receiptrequired elements as specifiedlisted in PartRequirement R6 parts 6.1- through 6.4.</p>	<p>receiving GIC flow information specified in Requirement R5; OR The responsible entity provided a documented responsefailed to documented comments received from a recipientinclude two of its GMD Vulnerability Assessment results and Corrective Action Plan, but it was more than 40 days but less than or equal to 50 days following the receiptrequired elements as specifiedlisted in PartRequirement R6 parts 6.1- through 6.4.</p>	<p>receiving GIC flow information specified in Requirement R5; OR The responsible entity provided a documented responsefailed to documented comments received from a recipientinclude three of its GMD Vulnerability Assessment results and Corrective Action Plan, but it was more than 50 days but less than or equal to 60 days following the receiptrequired elements as specifiedlisted in PartRequirement R6 parts 6.1- through 6.4.</p>	<p>greater per phase but did so more than 15 calendar months of receiving GIC flow information specified in Requirement R5; OR The responsible entity distributed its GMD Vulnerability Assessment results and Corrective Action Plan, if any, failed to functional entities having a reliability related need who requested-include four of the informationrequired elements as listed in writing but it was more than 60 days following the request; OR The responsible entity did not distribute its GMD Vulnerability Assessment results and Corrective Action Plan, if any, to functional entities having a reliability related need who requested the information in writing; OR</p>
--	--	--	---	---	---

						<p>The responsible entity provided a documented response to documented comments received from a recipient of its GMD Vulnerability Assessment results and Corrective Action Plan, but it was more than 60 days following the receipt as specified in Part Requirement R6 parts 6.1;</p> <p>OR</p> <p>The responsible entity did not provide a documented response to documented comments received from a recipient of its GMD Vulnerability Assessment results and Corrective Action Plan as specified in Part through 6.1.4.</p>
R7	Long-term Planning	High	<p>The responsible entity failed to conduct an assessment of thermal impact for 5% or less of its solely owned and jointly owned power transformers with</p>	<p>The responsible entity's <u>Corrective Action Plan</u> failed to <u>include/comply with</u> one of the required elements as listed in Requirement R7 parts 7.1 through 7.3;</p>	<p>The responsible entity's <u>Corrective Action Plan</u> failed to <u>include/comply with</u> two or more of the required elements as listed in Requirement R7 parts 7.1 through 7.3;</p>	<p>The responsible entity failed to conduct an assessment of thermal impact for more than 15% of its solely owned and jointly owned power</p>

			high-side, wye-grounded windings rated 200 kV or higher. <u>N/A</u>	OR The responsible entity failed to conduct an assessment of thermal impact for more than 5% up to (and including) 10% of its solely owned and jointly owned power transformers with high-side, wye-grounded windings rated 200 kV or higher <u>7.3.</u>	OR The responsible entity failed to conduct an assessment of thermal impact for more than 10% up to (and including) 15% of its solely owned and jointly owned power transformers with high-side, wye-grounded windings rated 200 kV or higher <u>7.3.</u>	transformers with high-side, wye-grounded windings rated 200 kV or higher. The responsible entity's Corrective Action Plan failed to comply with three of the elements in Requirement R7 parts 7.1 and 7.3; OR The responsible entity did not have a Corrective Action Plan as required by Requirement R7.
R8	Long term Planning	Medium	The responsible entity provided a copy of its assessment of thermal impact to the Planning Coordinator and Transmission Planner but it was more than 90 days but less than or equal to 120 days following its completion.	The responsible entity provided a copy of its assessment of thermal impact to the Planning Coordinator and Transmission Planner but it was more than 120 days but less than or equal to 130 days following its completion.	The responsible entity provided a copy of its assessment of thermal impact to the Planning Coordinator and Transmission Planner but it was more than 130 days but less than or equal to 140 days following its completion.	The responsible entity provided a copy of its assessment of thermal impact to the Planning Coordinator and Transmission Planner but it was more than 140 days following its completion. OR The responsible entity did not provide a copy of its assessment of thermal impact to the Planning Coordinator and Transmission Planner.

C. Regional Variances

None.

D. Interpretations

None.

E. Associated Documents

None.

Guidelines and Technical Basis

Benchmark GMD Event (Attachment 1)

The benchmark GMD event defines the geoelectric field values used to compute GIC flows that are needed to conduct a GMD Vulnerability Assessment. A white paper that includes the event description, analysis, and example calculations is available on the Project 2013-03 Geomagnetic Disturbance Mitigation project page:

<http://www.nerc.com/pa/Stand/Pages/Project-2013-03-Geomagnetic-Disturbance-Mitigation.aspx>

Requirement **R1R2**

A GMD Vulnerability Assessment requires a ~~de~~-GIC System model, which is a dc representation of the System, to calculate GIC flow ~~which is~~. In a GMD Vulnerability Assessment, GIC simulations are used to determine transformer Reactive Power absorption and transformer thermal response. Details for developing the GIC System model are provided in the NERC GMD Task Force guide: Application Guide for Computing Geomagnetically-Induced Current in the Bulk Power System. The guide is available at:

http://www.nerc.com/comm/PC/Geomagnetic%20Disturbance%20Task%20Force%20GMDTF%202013/GIC%20Application%20Guide%202013_approved.pdf

Requirement **R2R3**

The GMD Planning Guide developed by the NERC GMD Task Force provides technical information on GMD-specific considerations for planning studies. It is available at:

http://www.nerc.com/comm/PC/Geomagnetic%20Disturbance%20Task%20Force%20GMDTF%202013/GMD%20Planning%20Guide_approved.pdf

The diagram below provides an overall view of the GMD Vulnerability Assessment process:

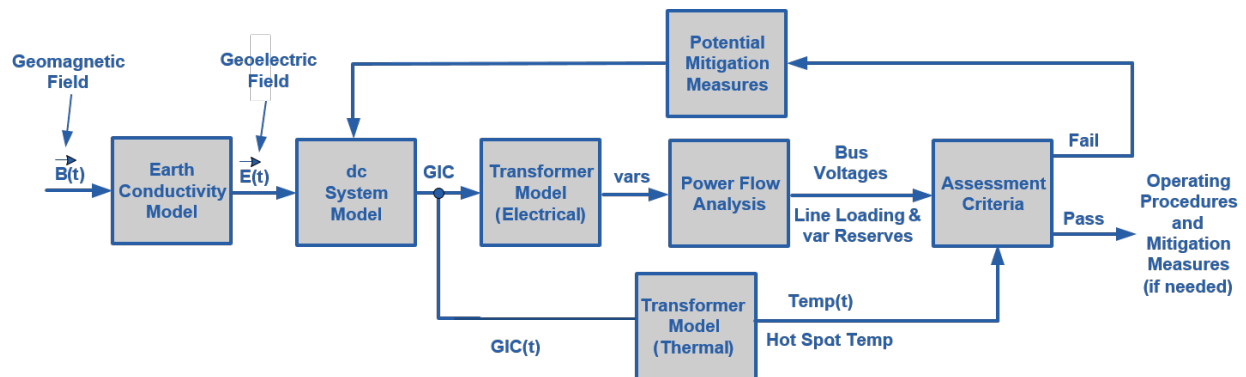

Requirement **R3R5**

The transformer thermal impact assessment specified in Requirement R6 is based on GIC time series information for the Benchmark GMD Event. This GIC information is determined by the planning entity through simulation of the GIC system model and must be provided to the entity responsible for conducting the thermal impact assessment.

Application Guidelines

The maximum effective GIC value provided in part 5.1 is used to screen the transformer fleet such that only those transformers that experience an effective GIC flow of 15A or greater are evaluated.

The effective GIC time series, GIC(t), provided in part 5.2 is used to conduct the transformer thermal impact assessment (see white paper for details).

The peak GIC value of 15 amps per phase has been shown through thermal modeling to be a conservative threshold below which the risk of exceeding known temperature limits established by technical organizations is low. Additional information is available in the transformer thermal impact assessment white paper:

<http://www.nerc.com/pa/Stand/Pages/Project-2013-03-Geomagnetic-Disturbance-Mitigation.aspx>

Requirement R6

The thermal impact assessment of a power transformer may be based on manufacturer-provided GIC capability curves, thermal response simulation, or other technically justified means. A process for conducting the assessment is presented in the white paper posted on the project page.

<http://www.nerc.com/pa/Stand/Pages/Project-2013-03-Geomagnetic-Disturbance-Mitigation.aspx>

The threshold criteria and transformer thermal impact must be evaluated on the basis of effective GIC. Refer to the white paper for additional information.

Requirement R7

Technical considerations for GMD mitigation planning are available in Chapter 5 of the GMD Planning Guide. Additional information is available in the 2012 Special Reliability Assessment Interim Report: Effects of Geomagnetic Disturbances on the Bulk-Power System:

<http://www.nerc.com/pa/RAPA/ra/Reliability%20Assessments%20DL/2012GMD.pdf>

Requirement R7

The thermal impact assessment of a power transformer may be based on manufacturer provided GIC capability curves, thermal response simulation, or other technically justified means. A process for conducting the assessment is presented in the whitepaper posted on the project page.